

# CHALLENGER® 1 AL5760



## Benefits

- Challenger 1 gives excellent light control; reducing light overspill, upward light and glare
- Includes a double asymmetric distribution with Flat Glass Technology
- Designed for lighting outdoor sports grounds and smaller sports stadiums where obtrusive light control is an essential requirement
- The Challenger 1 floodlight now contains a factory fitted 2kw cut-out ignitor which offers better protection for the lamp and floodlight cabling

## Technical Features

- Body of high-pressure die cast aluminium, first given a zinc chromate substrate, then finished in RAL7035 light grey polyester powder coating for optimum protection against harsh environments

- Narrow, medium and wide beam, double asymmetric light distributions
- Toughened front glass, secured within an aluminium frame
- Double asymmetric reflector system of high purity, polished and anodised aluminium. Incorporating an internal baffle to improve efficiency and reduce glare
- Galvanised steel stirrup, with additional locking screws

- Sealed to IP66; with silicone rubber gasketing
- Electrical connection box (IP66) housing ignitor, located on the side of the stirrup, fitted with 2 x GORE™ membrane breathers
- Simple aiming using a separate aiming device for accurate results
- Breather management system regulates air flow through the cable hose and in/out through IP67 GORE™ membrane. This method alleviates stress on the front glass





	Beam Type	Lamp: Manufacturer Product Code	Lamp Manufacturer	Lamp: Abacus Product Code	Lampholder Type
<b>AL5761</b>	Narrow	2kW: MHN-LA 2000W/842 & 956	Philips	LPP2000MHN-TD (842) & LPP2000/D (956)	XWH UNP
<b>AL5762</b>	Medium	2kW: MHN-LA 2000W/842 & 956	Philips	LPP2000MHN-TD (842) & LPP2000/D (956)	XWH UNP
<b>AL5763</b>	Wide	2kW: MHN-LA 2000W/842 & 956	Philips	LPP2000MHN-TD (842) & LPP2000/D (956)	XWH UNP
<b>AL5764</b>	Narrow	2kW: HQI-TS 2000W/N/L K12S FS1	Osram	LPW2000M/LA	K12s-7
<b>AL5765</b>	Medium	2kW: HQI-TS 2000W/N/L K12S FS1	Osram	LPW2000M/LA	K12s-7
<b>AL5766</b>	Wide	2kW: HQI-TS 2000W/N/L K12S FS1	Osram	LPW2000M/LA	K12s-7
<b>AL5767</b>	Narrow	2kW: MH-TS 2000W/L/K12/45K	Venture	LPV2000M/LA	K12s-7
<b>AL5768</b>	Medium	2kW: MH-TS 2000W/L/K12/45K	Venture	LPV2000M/LA	K12s-7
<b>AL5769</b>	Wide	2kW: MH-TS 2000W/L/K12/45K	Venture	LPV2000M/LA	K12s-7
<b>AL5770</b>	Narrow	1kW: MHN-LA 1000W/842 & 956	Philips	LPP1000MHN-TD (842) & LPP1000MHD-TD (956)	XWH UNP
<b>AL5771</b>	Medium	1kW: MHN-LA 1000W/842 & 956	Philips	LPP1000MHN-TD (842) & LPP1000MHD-TD (956)	XWH UNP
<b>AL5772</b>	Wide	1kW: MHN-LA 1000W/842 & 956	Philips	LPP1000MHN-TD (842) & LPP1000MHD-TD (956)	XWH UNP
<b>AL5773</b>	Narrow	2kW: MHN-FC2000/740	Philips	LPP2000MHN-FC	XW UNP
<b>AL5774</b>	Medium	2kW: MHN-FC2000/740	Philips	LPP2000MHN-FC	XW UNP
<b>AL5775</b>	Wide	2kW: MHN-FC2000/740	Philips	LPP2000MHN-FC	XW UNP
<b>AL5776</b>	Narrow	1kW: MHN-FC1000/740	Philips	LPP1000MHN-FC	XW UNP
<b>AL5777</b>	Medium	1kW: MHN-FC1000/740	Philips	LPP1000MHN-FC	XW UNP
<b>AL5778</b>	Wide	1kW: MHN-FC1000/740	Philips	LPP1000MHN-FC	XW UNP

### Lamp references

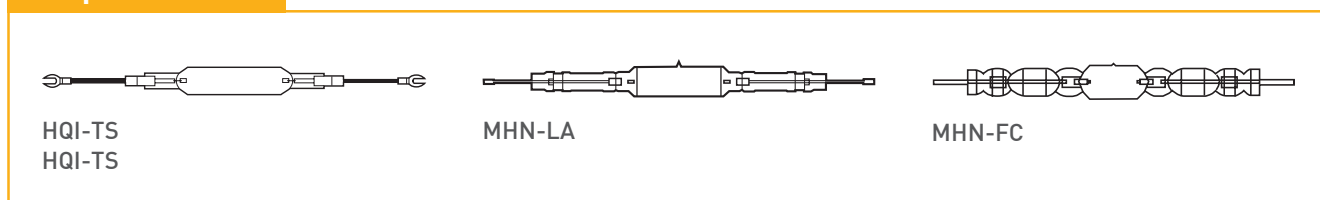

Lamp Manufacturer & Lamp Ref.	Lamp Wattage	Colour Temp	RA:	Lamp Lumen Output: (Initial lm)	Lamp Current:	Supply Voltage	Total Circuit Power:
<b>Venture</b>							
MH-TS2000W/L/K12/4K	2kW	4500K	65	240,000 l.lm	10.3A	380/400/415V	2150W
<b>Philips</b>							
MHN-LA2KW400V/842	2kW	4200K	80	220,000 l.lm	9.6A	380/400/415V	2105W
MHN-LA2KW400V/956	2kW	5600K	90	190,000 l.lm	10.3A	380/400/415V	2113W
MHN-LA1KW230V/842	1kW	4200K	80	100,000 l.lm	9.3A	230/240V	1040W
MHN-LA1KW230V/956	1kW	5600K	90	90,000 l.lm	10.1A	230/240V	1040W
MHN-FC2000W/740	2kW	4200K	60	210,000 l.lm	10.1A	380/400/415V	2032W
MHN-FC1000W/740	1kW	4100K	65	93,000 l.lm	10A	230/240V	1040W
<b>Osram</b>							
HQI-TS2000WNL	2kW	4400K	65	230,000 l.lm	10.7A	380/400/415V	2180W
HQI-TS2000WDL	2kW	5400K	85	20,5000 l.lm	10.3A	380/400/415V	2180W

Technical information may alter dependent on control gear used

## Dimensions

Dimensions in mm

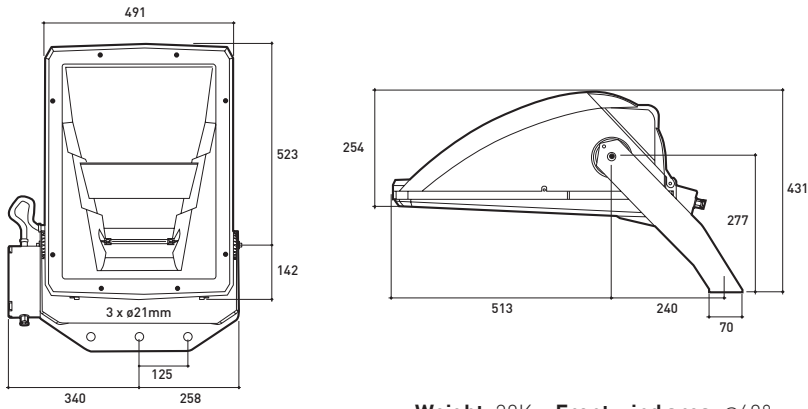

### Mounting:

Stirrup mounted using M20 fixing  
Stirrup adjustment +/- 140°

**Weight:** 20Kg. **Front wind area:** @60° setting (Flat Glass) - 0.126m<sup>2</sup> 70° max setting (+10 elevation) - 0.135m<sup>2</sup>.  
**Side wind area:** 0.108m<sup>2</sup>

## Maintenance



### Easy Maintenance:

Access to the lamp by means of opening the rear door

## Key features

### Abacus Lighting Control System

A combination of efficient lighting design and careful floodlight design has rewarded Abacus with an international reputation for pioneering high performance floodlighting combined with effective control of obtrusive light.

Specific to Challenger 1 the Abacus Light Control System consists of a series of complimentary measures to effectively control light pollution.



### Double Asymmetric Reflector

The double asymmetric reflector is designed to ensure full flow of light over the lit area from each floodlight. With the main beam emitted from the floodlight at an angle of 60 degrees forward from the normal to the front glass, it results in a flat appearance (fig 1). The benefit is that less of the reflector is visible to spectators and onlookers, resulting in low glare to the surrounding locality.

### Internal Baffle

The internal baffle re-directs upward stray light back into the floodlight beam, providing increased efficiency. At angles above the beam the baffle shields direct lamp glare (fig 3).

Produces sharp run back above high peak resulting in greater overspill containment and minimal intrusion to adjacent areas bordering the installation (fig 2).

fig.1

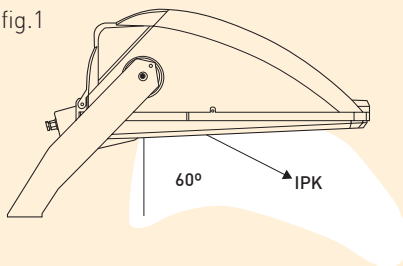

fig.2

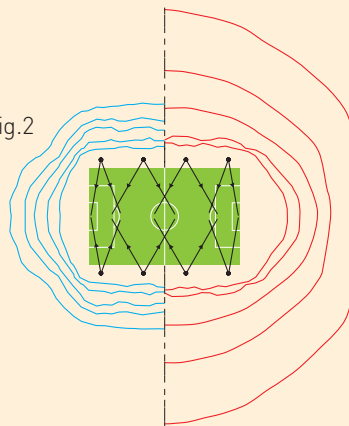
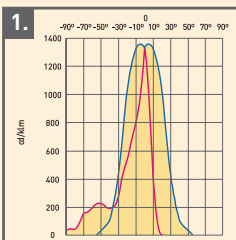
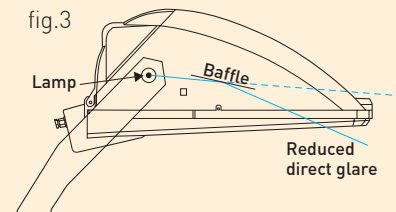
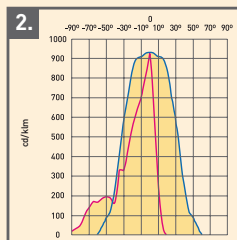

fig.3



**AL5764/AL5767**  
2kW HQI - TS / MH - TS  
Narrow beam



**AL5765/AL5768**  
2kW HQI - TS / MH - TS  
Medium beam

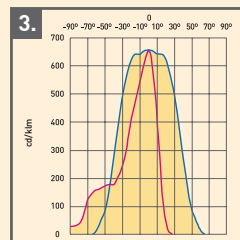

**AL5766/AL5769**  
2kW HQI - TS / MH - TS  
Wide beam